



SaunaFin

Saunas & Steambaths

LK FLOATING BENCH SAUNA KIT-HEMLOCK

LK FLOATING BENCH SAUNA KIT-HEMLOCK

The Floating Bench option is available only with LK Plus kits.

Floating benches refer to a bench with no visible floor supports.

Bench tops are 1×4 hemlock.

The Bottom Bench extends fully under the top bench. Top=20", Bottom=36"

YOU SUPPLY:

- You provide the 2×6 SPF studs-to-frame bench.
- We supply the USP inverted Joist hanger, Lumber Loc screws and driver bit.

WE SUPPLY:

- 1 × 4 Select, Clear hemlock for bench tops.
- Joist hanger.
- Lumber Loc Torx 20 screws.
- Torx 20 driver bit.

NOTE:

All doors and door jambs have some cedar.

Unless specified and ordered as Hemlock, all trim (corner molding, casing, heater guard) is made from cedar.

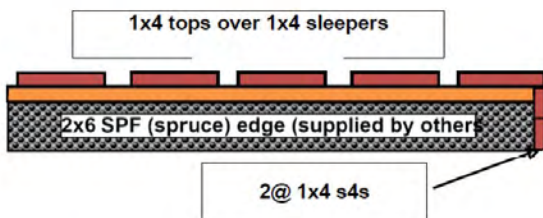

LK FLOATING BENCH STYLE SAUNA LINER KITS

INCLUDES 1×4 HEMLOCK BENCH TOPS. (SPRUCE BENCH SUB-STRUCTURE BY OTHERS)

BEFORE YOU BEGIN

READ ALL THE INSTRUCTIONS AND REVIEW THE MATERIAL LIST

Remember the old carpenters proverb: "Measure Twice, Cut Once"

SPECIAL NOTE FOR CONTRACTORS

If you have previous experience constructing saunas/steambaths we still recommend you read all instructions and carefully review the material list before you begin. Material is supplied in specified lengths for particular uses.

Be sure to confirm the hemlock direction on the sauna ceiling.

The kit has been checked and vetted thoroughly before leaving the SaunaFin workshop. Typically when "shortages" are encountered this is a result of pieces being cut incorrectly, leaving a shortfall elsewhere.

IMPORTANT HEMLOCK GRADING AND SELECTION:

Clear cedar kits use the finest "Grade 'A' & Better" tongue & groove cedar for lining material. Even with this top grade, you may find certain boards that are slightly imperfect. To remedy this, doing a pre-sort of your sauna kit to find these materials and try to "hide" these boards is worth doing. Install these boards behind the bench where they will not be visible. In the case of front wall boards, cut them so that you can hide less attractive boards behind the heater.

The cedar is finished on two sides to give you more flexibility in selecting the face you prefer.

When assembling benches, select the nicer side to be the bench top.

ALL MATERIALS ARE FIT FOR PURPOSE

The supplied Material List itemizes the lengths provided and for which wall (based on quotation and order placed). DO NOT reassign or reallocate material without first speaking with us.

The material supplied for the ceiling is clearly indicated.

If the material delivered does not correspond to your sauna design or layout, contact us before you install it. Do not cut down boards intended for something else. We will not provide additional material in these circumstances.



Check	Quantity	Length	Description
✓	32	6	1x4 t & g Ceiling
✓	29	8	back-panel door ends
✓	54	6	front
✓	25	6	front
✓	2	8	Extra t & g
✓	2	6	Extra t & g

FRAMING

This instruction manual has no details for general framing. It is assumed that you possess the basic carpentry skills needed to install this kit and have the know-how to frame the walls and hang a door.

The instructions note blocking as required to support the benches and heater. To do this, frame the walls and ceiling using 2" x 4" kiln-dried SPF (spruce, pine, fir) studs. The standard framed height is 83-1/2", but check the material list to confirm your sauna height as ordered. Try to provide extra blocking for heater mounting brackets and joist hangers. (See drawing #1,3,4).

See the Material List for your door rough opening.

Frame the walls at 16" in the center. If the walls are already framed and you wish to change the direction, they should be strapped using 1" x 2" spruce strapping at 16" in the center.



FRAME SIZE

Frame sauna to the size ordered (see material list). For example, if the sauna is 5' x 7', frame the walls to 5' x 7'. The actual sauna interior will be about one inch smaller. Unless otherwise ordered, the standard framed height is 83-1/2".

VENTING (See vent drawings #1, #6 & #7)

Sauna venting does not mean exhaust venting as you would for a shower. Venting aims to optimize the sauna's function by pulling hot air from the heater and dragging it to the far corner. Inlet and outlet vents should be on opposite sides and not be on the same wall.

For indoor saunas, venting shouldn't be channeled outdoors and can be directed to the sauna's indoor environment.

In general, for outdoor saunas, you'll have access to all the walls after construction, which means you could choose not to install vents initially, knowing they may be required later.



Inlet and Outlet Vents

One outlet slide vent cover is included with your kit. An inlet vent is typically a series of holes drilled through the hemlock lining. The heater conceals the holes. If there is a gap under the door and the heater is closed, the door gap can act as the inlet vent. An exterior grill is not included, but if you wish to install one, use painted aluminum (or other similar materials) to match the exterior decor.

The outlet vent requires a 4.5" x 4.5" opening. Most of these use spruce studs for the box openings. The inlet area should be 19 square inches. Sometimes, what is outside the sauna can limit the ability to install simple vents through the wall easily. In such cases, ducting over a drop ceiling and venting to an open indoor area may be possible.

Poor ventilation can lead to:

- Insufficient heat at the benches furthest from the heater.
- The sauna heater's integral high limit switch "tripping" because heat is trapped.

THE DOOR (See page #8)

See your "Material List" to verify your door selection and rough opening size. These are the typical options:

- **Frameless Glass** door rough opening is 27-1/2" x 76-1/2" to the finished floor. It allows for the 74" jamb and the 1-1/2" spacer with gap to install below jamb threshold. (Door = 24" x 72")
- **The rough opening of the Cedar Framed Insulated Glassdoor** is 26" x 76-1/2" to the finished floor. (Door = 24" x 74"). There is a gap under the door to allow for a backup air inlet.
- **Jamb Extension:** (See drawing #8a). A 1x2 trim is provided for jamb extension where required, with frameless glass doors and 11/16" lined kits.

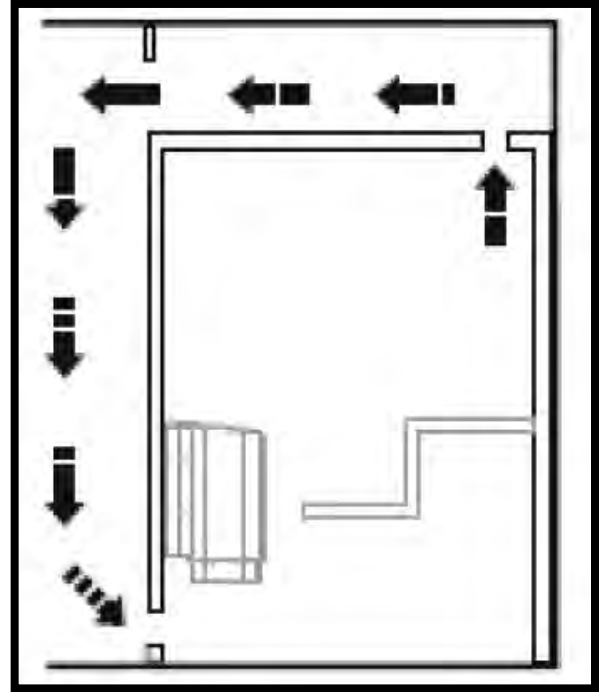
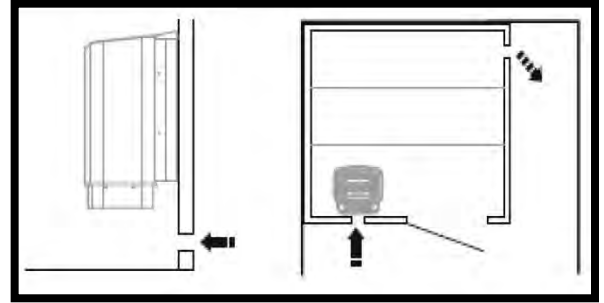

WIRING

For wiring information, see electrical wiring drawings included with selected heater/control.

NOTE: Wiring should only be installed by a qualified electrician.

An electrician should do the electrical rough-in wiring at this time. The wire size and wire pathway are dependent on the heater model and size. If you're using an outside control (not built into the heater), the thermostat should be installed at this stage. Install on the wall outside the sauna with the sensing bulb as indicated in the heater instruction manual.

- **Tylo Sport & Saaku.** These supply wires to the heater are controlled on the heater and have built-in sensors.
- **Tylo Plus or Combi with Pure or Elite control.** These supply wire to the heater. Sensor from the heater to 1" down from the ceiling, 3" from the edge of the heater (NOT in the corner). Note: The control cable is 15' from the bottom of the heater to control location. (50' available as option.)
- **Sauna Craft Controls.** A TPT3 or EL13, 3-gang box is provided with control for installation outside the sauna. Controls are line voltage. Locate the sensing bulb 1" maximum from the ceiling 1'- 2' from the heater.

For heaters up to 6kw, the supply wire goes first to the control and then from the control to the heater.

For heaters up to 7.5 kW and larger, there is a magnetic contactor and additional wires for the control circuit (field supplied).

- **The standard light fixture.** This is included as a surface-mounted marine light. A wall mount is recommended, and it requires an octogen electrical box, which is not included.

The light has a separate 120-volt power supply. A light switch is not provided.

If you have Tylo with Plus or Elite control, you can direct 120v through the heater and use the control to operate the light.

Optional recessed ceiling lights may be used in place of wall lights.



INSULATION

The walls and ceiling should be insulated using the 3 1/2", R-12 fiberglass insulation. Rockwool can be used as well.

FOIL BARRIER

To install the aluminum foil, staple it to the inside edge-face of the studs over the insulation. Overlap the seams by approximately 3". If it is paper-backed, install with the "shiny" side facing into the sauna.

DO NOT TAPE THE SEAMS. The foil is intended more as a heat reflector than a vapor barrier. Taping the seams can impede airflow. If the seams are taped, properly installed sauna vents are imperative.



TONGUE & GROOVE LINING (See drawing #1 & #5)

While not required, most sauna owners choose to line the ceiling first.

Before you begin, examine all the tongue and groove hemlock pieces. You may find certain boards you do not like, whether due to a knot or color. You can "hide" these boards by installing them behind benches or heater where they will not be visible.

The kit comes with several extra pieces of T&G hemlock at no additional charge.

Use the specified lengths of tongue and groove hemlock (see "Material Packing List"). Hemlock generally comes 1/4" below the foot. You are expected to trim each board to fit. Nail through the tongue to conceal all the nail heads (For blind nailing - See drawing #5).

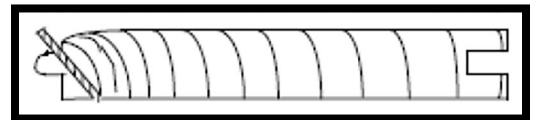

HORIZONTAL LINING (See drawing #1)

The hemlock wall pieces should be left about 1/2" off the floor. You should start above the base if a tile baseboard has been installed. Start on the floor and work your way up, ensuring the first board is level. Check the level every 4-6 boards. The first hemlock piece should be installed with the tongue facing up. There is up to a 1/32" variation in width. Corners may not line up perfectly. Corner molding is supplied.

EXTERIOR

These are NOT included unless ordered as an option. For exterior walls, drywall or paneling may be used to match your decor.

BENCHES (See drawings #9,10,11,12 for bench assembly details)

Clear hemlock 1×4 boards for the bench TOPS. Bench GIRTHS (sleepers) are 1×4

BEFORE DOING ANY FASTENING

Select the boards to ensure the BETTER side of the board comes out on the sitting surface.

While you build the benches, the better side will be faced down because you are fastening from the bottom. That way, you do not get any nails showing up on the finished surface. Use the 1-1/4" nails supplied.

If the sauna is 5' or more deep, the top bench is 20" wide (5 boards + eased edge), and the bottom bench is 36" wide (9 boards + eased edge). If the sauna is under 5' deep, make the bottom bench 28".

BENCH SUPPORTS (for Floating bench tops) NOT INCLUDED

Bench framing for floating benches is not provided. To build a bench sub-structure, you must provide your own 2×6 SPF (spruce, pine, fir). We offer hemlocks for the bench tops.

**BENCH GIRTHS** (drawing #9,10,11,12)

For the knotty cedar, the girths should be nailed from the bottom of the bench. You should fasten the bench girth 1' on the center. The top girth is 19-14" and the bottom girth is 35-1/4". This may be provided as one 5' piece for you to cut yourself.

**"L" SHAPED RETURN BENCH** (drawing #13)

Where there is only a single tier, L"- shaped return bench along the side wall, it is typically installed as a top bench.

For an "L"- bench, the bench framing is installed as for standard benches. Fasten one joist hanger to the wall.

Fasten the other joist hanger to the face of the main bench.

If you plan to create an L-bench with your own frameless glass front wall, your contractor will need to supply or fabricate angle iron support for the open end of the bench, where it meets the glass.



HEATER

Sauna Craft heaters (up to 9kw) can be mounted in the corner or on a straight wall. Generally, the least space is occupied by mounting the heater on the wall, 2" from the corner.

Tylo and Saaku heaters can only be mounted on a straight wall.

GUARD RAIL (See drawing #14)

Use the 2×2 for the vertical posts and the 1×3 for the horizontal rails.

Tylo Heaters have a cool-touch shell, and some sauna owners choose not to install the guard. However, a guard is provided for you, and it is recommended that you install it.

**FASTENERS**

1-1/4 finishing galvanized nails for T&G lining and bench tops.

Treat deck screws.

**FLOATING BENCH HARDWARE**

The joist hangers are typically 2×6 but can also be 2×4 for benches 6' or shorter. It's best to use "Lumber Lok" screws to fasten joist hangers. You'll need a T-20 torx bit for the "Lumber Lok" screws.

FLOOR (option) (See drawing #15)

Use a 1×4 hemlock with a square edge laid over 1×4 sleepers.

The top boards should be 1/2" apart. The sleepers should be placed at 1'-0" in the center.

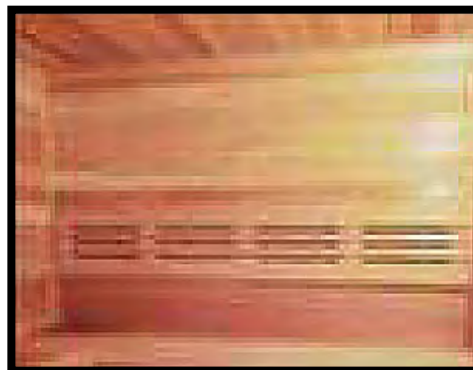
**BACKREST** (option) (See drawing #16)

#1

HORIZONTAL LINING IS STANDARD. CHECK YOUR MATERIAL LIST TO CONFIRM YOUR SAUNA LINING

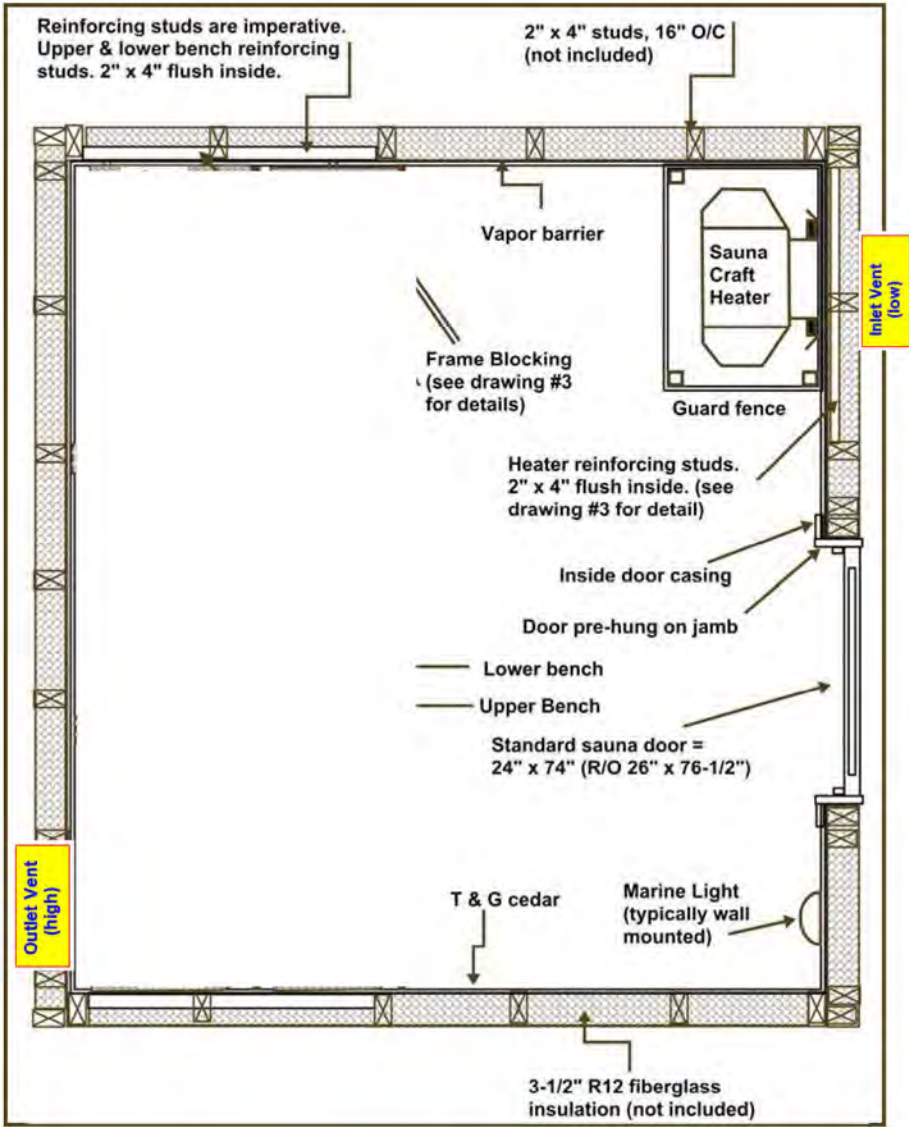
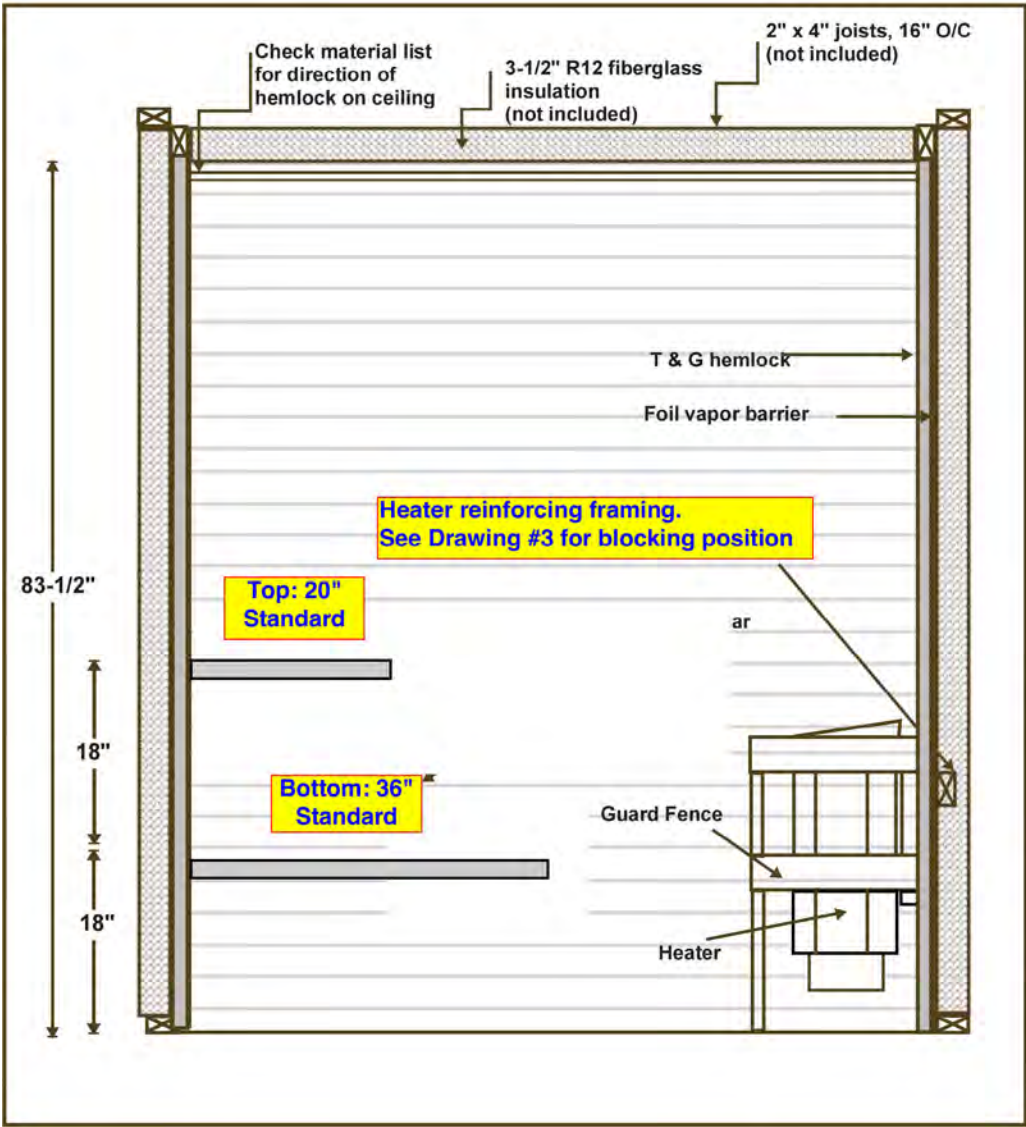

NOTE: This drawing is generic and does not necessarily reflect your exact sauna. Check your Sauna Material List for specifics on your sauna.

#3

REINFORCING STUDS FOR FLOATING BENCHES AND HEATERS

Bench Blocking

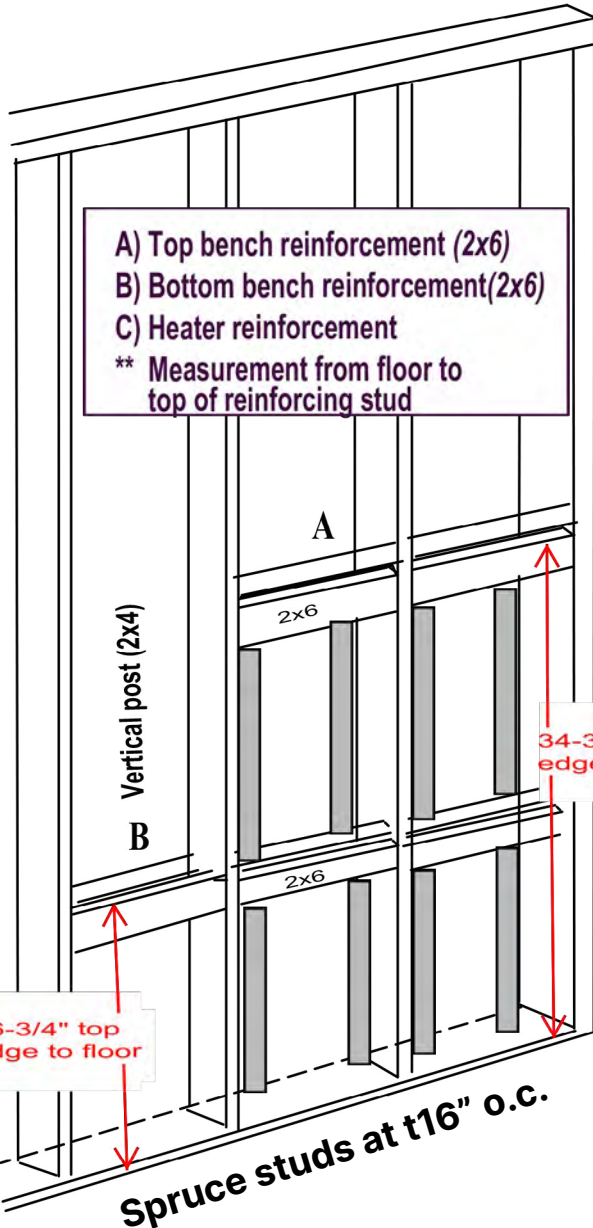

Bench Blocking

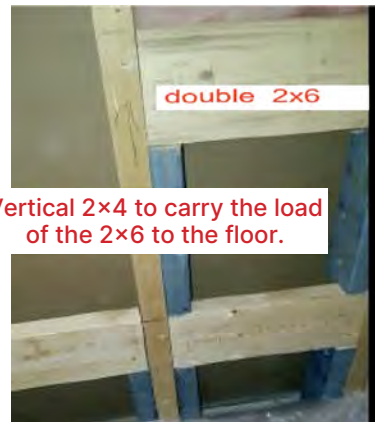

Double plate 2x6 blocking with 2x4 vertical reinforcing posts to carry full bench load.

#4

REINFORCING STUDS FOR HEATERS

Sauna Craft

(Add blocking on adjoining wall if heater to become mounted)

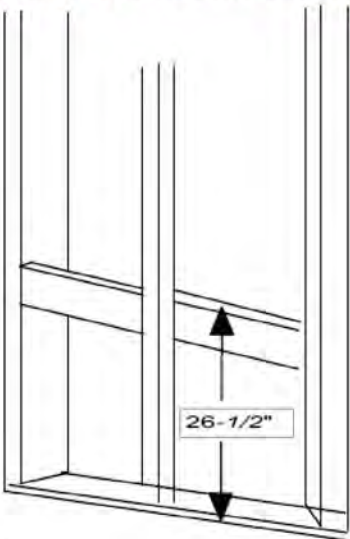

26-1/2"

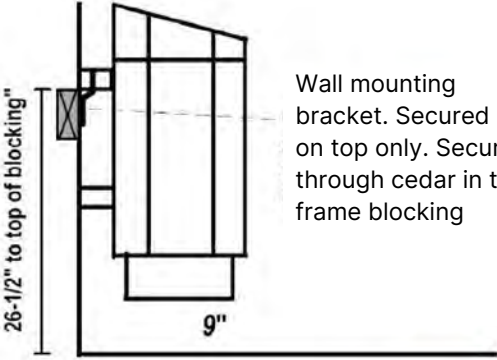

26-1/2" to top of blocking"

9"

Wall mounting bracket. Secured on top only. Secure through cedar in to frame blocking

Tylo

From top of 2x4 blocking to the floor

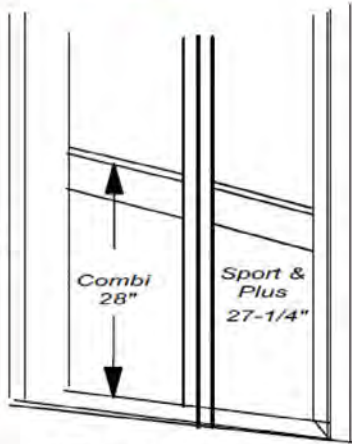

Combi 28"

Sport & Plus 27-1/4"

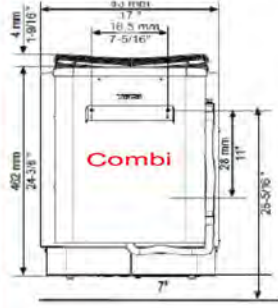

Combi

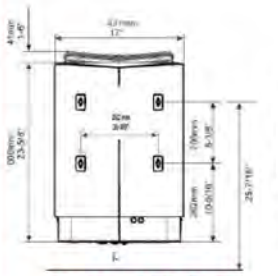

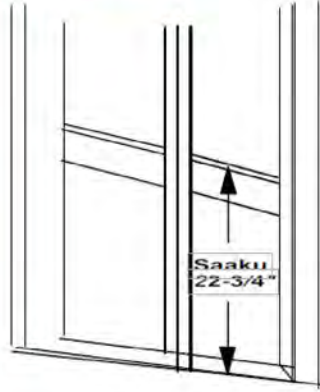

Sport & Plus

Saaku.

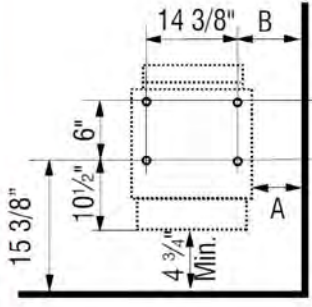

Saaku 22-3/4"

#5

TONGUE & GROOVE HIDDEN NAILING

1 - 1/4" galvanized finishing nails for lining (supplied). Many prefer to use their own brand of nail gun for this task. Nail through the tongue and hide the inside groove.

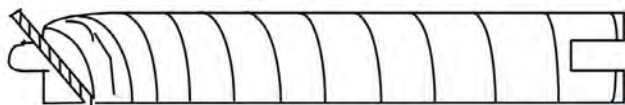

VENT DETAILS

Proper sauna venting is essential to sauna heater operation and to heat the sauna room effectively. Sauna ventilation is passive, and there is no mechanical fan. It is not part of the HVAC or bathroom exhaust.

INLET goes low behind the heater (usually on the front wall). Typically, it is simply holes drilled through cedar on the sauna side.

Fixed cedar grill (instead of holes) is available as an option. The exterior has an aluminum grill (not included) to match the exterior décor.



Fixed cedar grill: Optional with LK Plus. Incl with LK Premium

OUTLET is located high on the wall, diagonal from the inlet.

Cedar slide cover on the outlet (sauna side). The exterior has an aluminum grill (not included) to match the exterior décor.



Slide Vent Cover: One is included with every sauna material kit.

Exterior Grill: This is not included. Select one to match your décor.

SLIDE VENT COVER

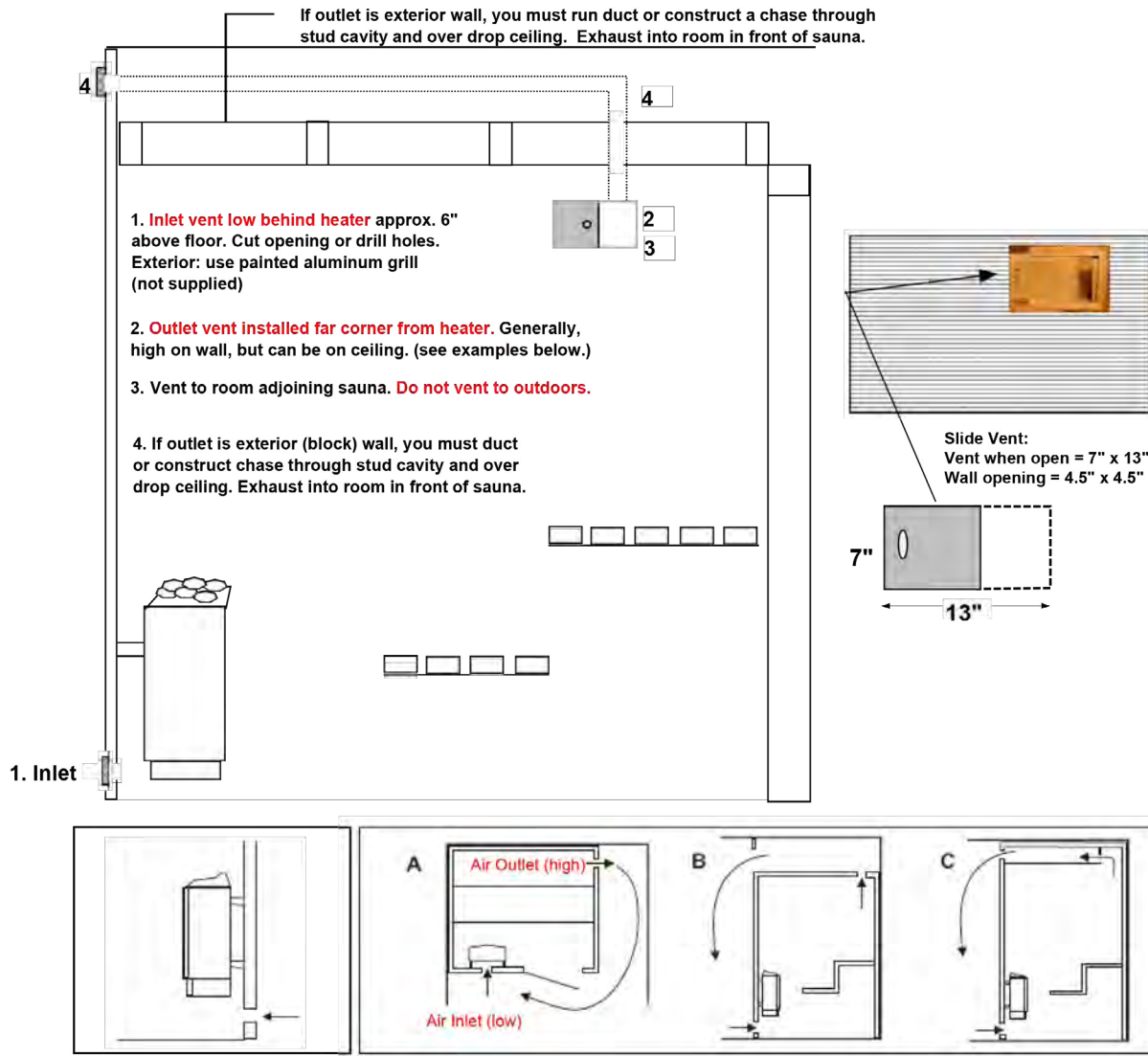

The inlet vent should be driven straight through the wall directly below the center of the heater. The cross-section of the vent for a wall-mounted sauna is approx. 19 sq.in. For larger saunas, approx. 40 sq.in.

Position the air inlet and outlet vents as far away from one another as possible (diagonally opposite). The outlet vent should be located high on a wall or in the ceiling and should have the same cross-section area as the inlet vent. Spent air should always be led back into the house – not discharged directly to the outside.

CAUTION: Do not install inlet and outlet vents on the same wall. Bad ventilation can be worse than no ventilation.

A: Outlet vent through the sauna wall (seen from above). The vent is placed high up, near the ceiling.

B: Outlet vent through the cavity above the sauna ceiling (seen from the side).

C: Outlet vent through a drum under the ceiling in the sauna (seen from the side). The outlet duct should be placed at an angle between the ceiling and the wall. The drum can be built out of wooden paneling and have the same area as the outlet vent.

Inlet: If you're drilling holes for an inlet, these must equal the specified sq-inch requirement. Six 2" or eight 1.75" holes are sufficient.

#8

SAUNA DOORS

NOTE: Rough Opening means above the “finished” floor, i.e., above the tile.



Frameless

R/O=27-1/2" x 76-1/2 incl
bottom spacer with gap

(Hinge is reversible)



Cedar Framed Insulated Glass

R/O=26" x 76-1/2 gap under the
door (non-reversible)

NOTE: Gap or spacer can be deleted if you have effective
cross ventilation as detailed in the manual.



Trim/Double Header

If you don't use a frameless
door bottom spacer, or the
door is shorter than R/O for
another reason, you can
“double case” the header.



Tips

If you don't want to see
screws on the jamb, you can
screw behind the stops.

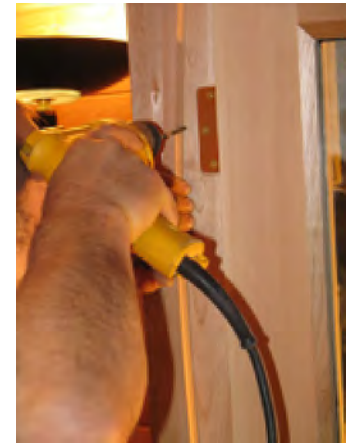

After installing
the door,
replace the
center screw
on each hinge
with the
longer screws
provided with
the kit.



NOTE: We do not provide instructions for how to hang a door. That is not something unique to saunas. We assume the installer knows how to shim, square, and secure a door in place. If not, there are numerous YouTube video demonstrations.

JAMB EXTENTION DETAIL

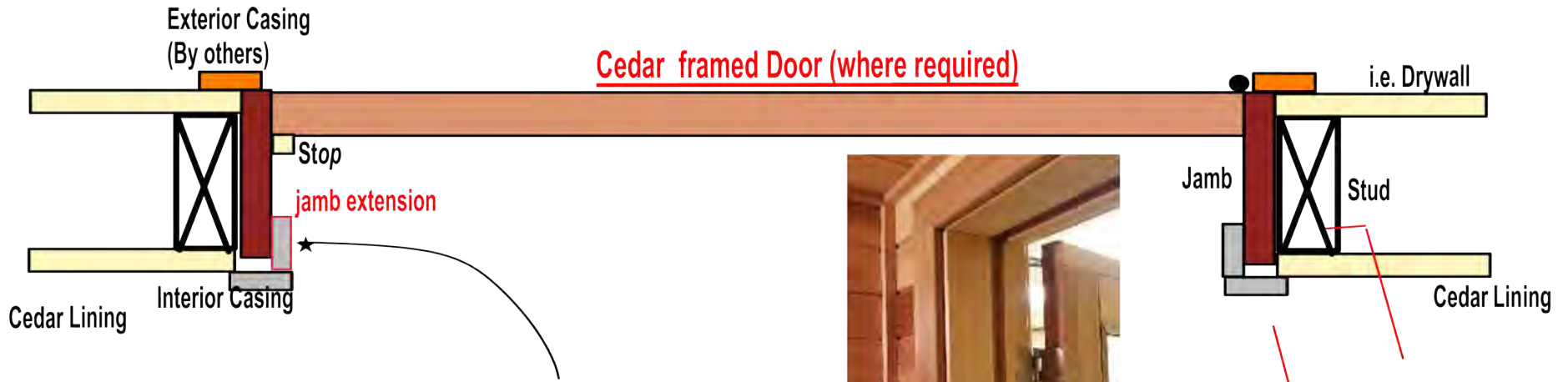

Where stud wall is thicker than standard; i.e 2x6 studs, a 1x2 for jamb extension.
 Secure jamb extension to jamb so that it extends flush with inside cedar lining of sauna.
 Install inside casing to conceal the gap at the jamb.

Exterior finish & Casing (By others)

Frameless Glass Door

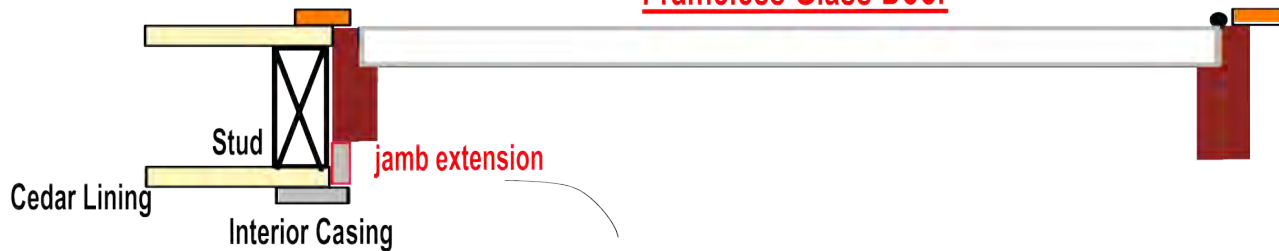

*For Frameless door jamb, nail jamb extension to stud.
 Trim so its flush to inside cedar lining.
 Use 1x2 jamb extension. Trim as needed*

#9

BENCH CONSTRUCTION - 1X4 OVER 1X4

(For floating benches, sitting on 2x6 spruce joist)

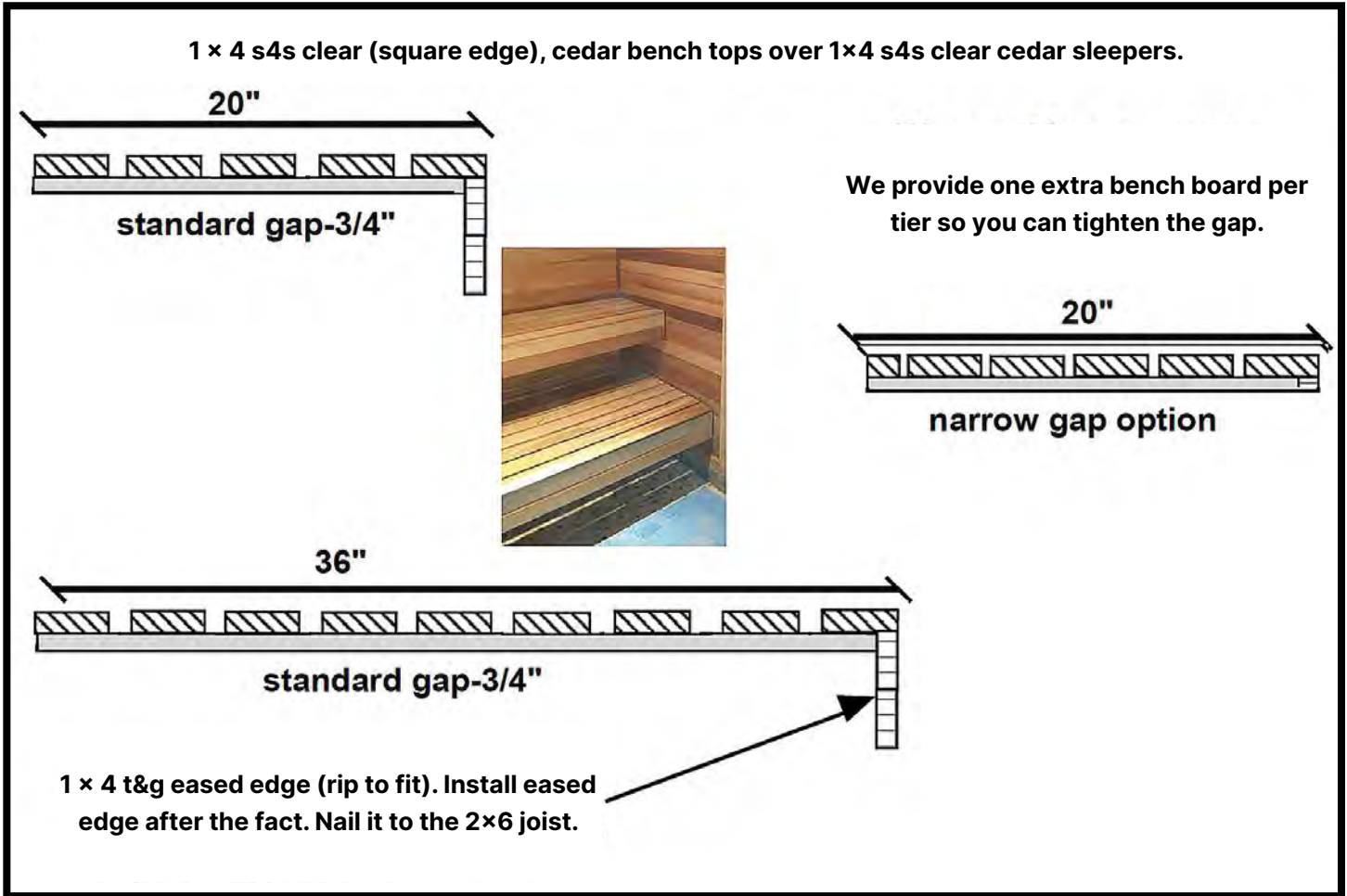

#10

BOTTOM VIEW OF BENCH

Fasten girths from the bottom to avoid exposed nails on the sitting surface. Be careful not to nail through the seating surface. We recommend using carpenter's glue along with the supplied nails.

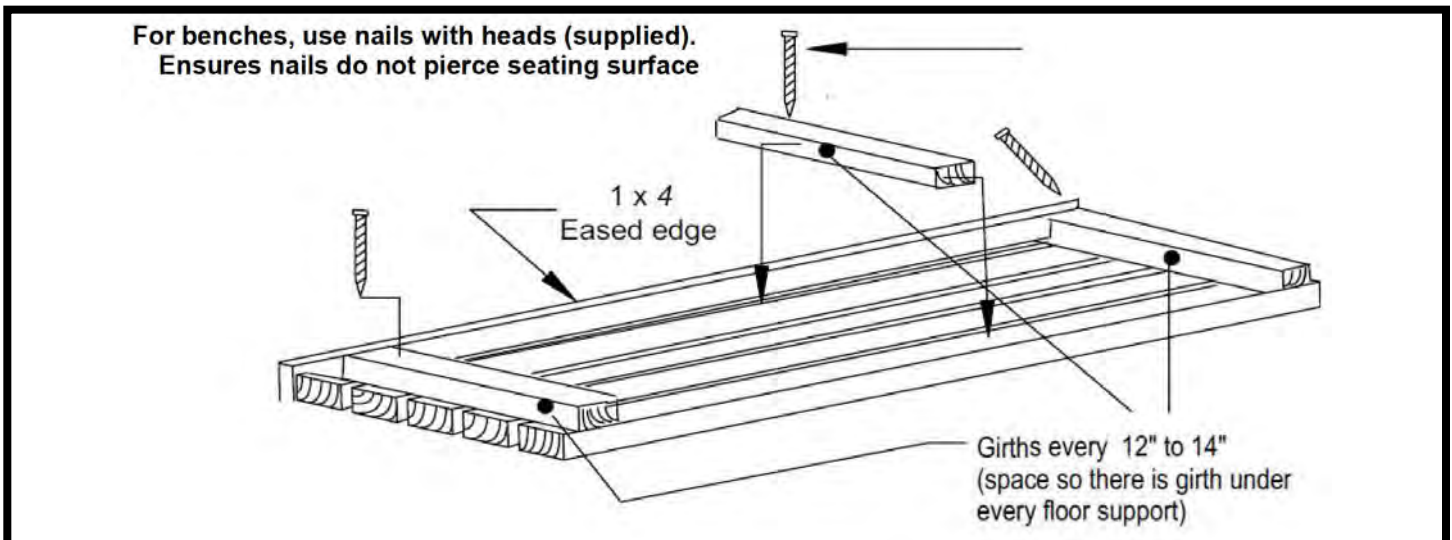

#11

BENCH CLEAT & GIRTH FOR ALL BENCHES

1"x4" BENCH GIRTH

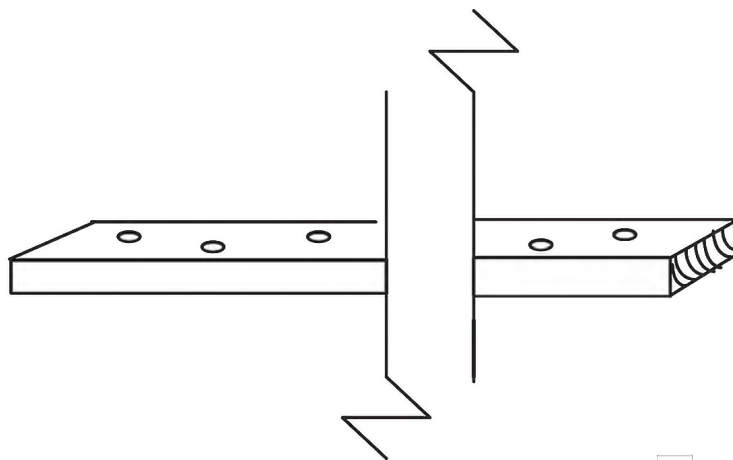

Girths are approx. every 12." Space so that there will be grith over each joint cross-blacking.



#12

FLOATING SAUNA BENCH

1x4 (clear) tops over 1x4 girth over 2x6 Spruce joist (on edge).
2x6 sitting on Joist Hanger

Bench Sub-Structure (joists) By Others - We provide joist hanger & screws)

1x4 tops over 1x4 sleepers w/ 3/4" gap

2x6 SPF (spruce) edge (supplied by others)

2@ 1x4 s4s (trim as required)

double plate of 2x6 with vertical 2x4 to transfer load to floor.

Secure joist hanger through hemlock in to 2x6 blocking Attach one 2x6 to joist hanger (using Lumber Loc screws & bit provided) Attach second 2x6 to face for additional support

Back 2x6 to fastened through hemlock in to vertical studs (blocking not required)

Back 2x6 support Secure to back wall (into wall studs)

Double 2x6 @ front One on joist hanger

2x6 cross member 12" o.c.

#13

OPEN ENDED BENCH METAL SUPPORT (By Others)

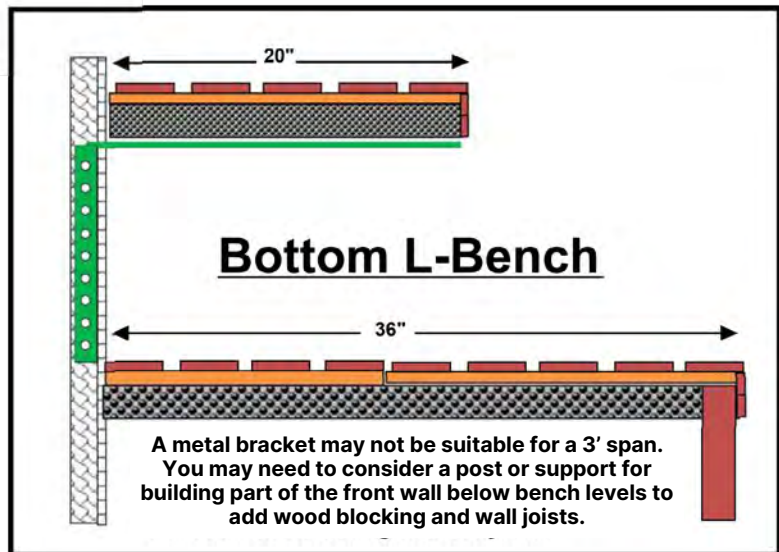
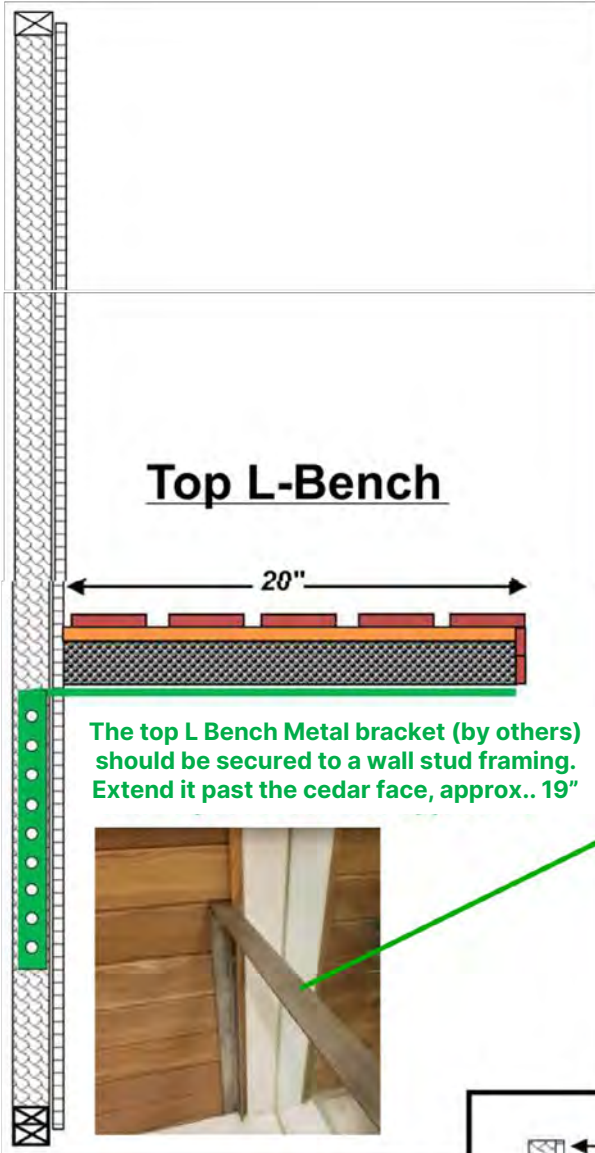

#14

STANDARD HEATER GUARD FENCE

Heater Guard: two sided, three sided or high sided as required

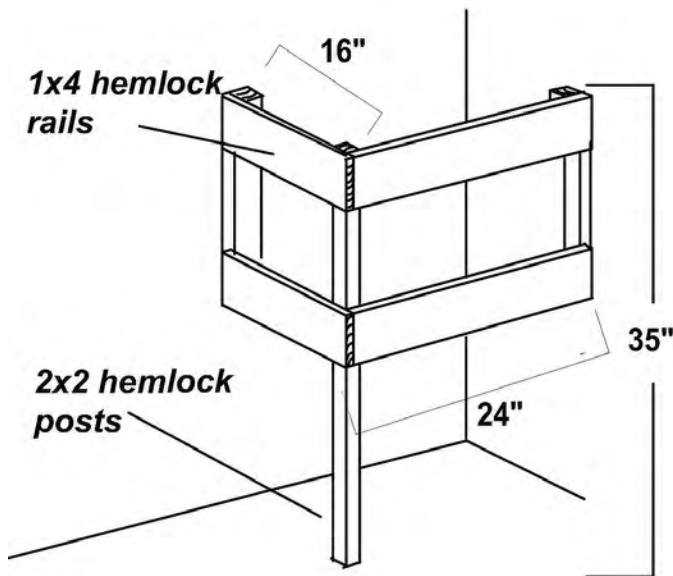

#15

OPTIONAL 1" X 4" DUCKBOARD FLOOR (WHERE ORDERED)

1x4 cedar tops
- 1/2" to 5/8" spacing

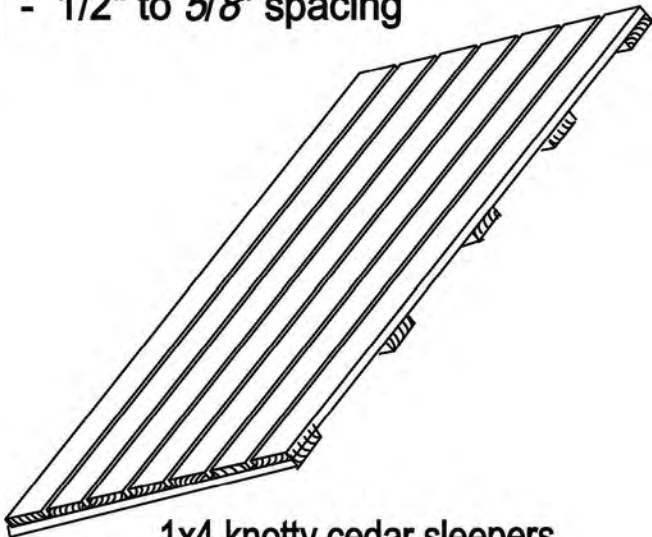

1x4 knotty cedar sleepers
- 12" O.C.



#16

BACKREST (OPTIONAL)

BACKREST

Place a 1X4 hemlock over the sleepers. Screw the sleeper to the support through the gap.

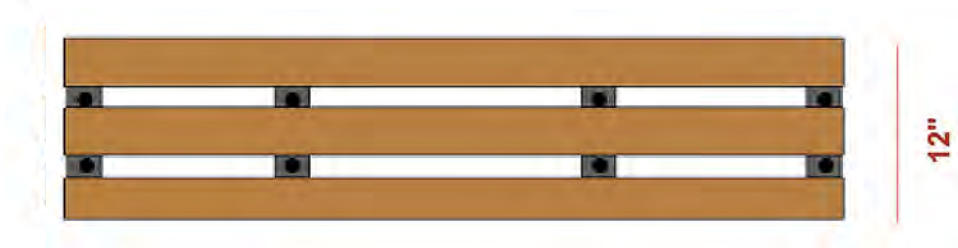

Walls and backrest all from clear hemlock



Assemble the backrest from the back so the nicer surface is facing the front. Nail it using 1" nails with the heads provided.

There should be an approx. 5/8" gap between bench tops for 12" height. The sleepers should be set at approximately every 2'.

Tip: Nailing the backrest to the wall looks nicer.

HOW TO TAKE A SAUNA

1. Start with a brief shower using warm water and soap. Rinse thoroughly. Do not towel dry.
2. Enter the pre-heated sauna set to 80°-90°C (176°-194°F). Relax and allow your body to perspire freely in the soft, dry heat. Do not throw water on the rocks in this first session. Do not expect to begin and finish your sauna in a few minutes. Even in the extreme heat of a sauna, it takes time for your body temperature to rise so you perspire freely.
3. Cool off with a cold shower.
4. How long you stay in the sauna is up to you. It depends on your comfort level. It is not an endurance test. People often start at 5-10 minute intervals and work up to longer periods.
5. Re-enter the sauna. Sprinkle water on the hot rocks to add steam and increase the humidity. Adding water will increase the feeling of heat and assist the perspiration process. Add a few drops of scented essence, such as eucalyptus, into the water you splash on the rocks. It will disperse throughout the sauna.
6. Take a cold shower. Repeat the sauna/cold water cycle as often as you desire.
7. Dry yourself completely, then sit or lie down, letting your body relax.
8. Dress and have a light post-sauna snack.

NOTE: When used for the first time, you will notice smoke coming off the heater elements. This process is normal. Leave the door open and allow the sauna to run for about 20 minutes.





SaunaFin

Saunas & Steambaths

SAUNAFIN SAUNA & STEAM

106 Rayette Road, Unit 1, Concord, ON, L4K 2G3

TOLL-FREE

1-800-387-7029

PHONE

905-738-4017

EMAIL

info@saunafin.com

WEB

www.saunafin.com