



SaunaFin

Saunas & Steambaths

SAUNA KIT ROUGH IN DETAILS

SAUNA KIT ROUGH IN DETAILS

This rough-in guide is for our Sauna Material kits.

For more detail see "Sauna Material Kits" on website: <https://www.saunafin.com/resources>

YOU SUPPLY:

FRAMING: Use 2 × 4 construction grade spruce studs to frame the walls and ceiling. Unless otherwise specified, for saunas up to 8' x 8', the walls are LINED HORIZONTALLY and FRAMED VERTICALLY. Frame the walls at 16" on center. Frame or strap the ceiling to an inside height of 83-1/2". Frame the ceiling so that the cedar will run the shortest direction. Provide extra blocking for bench supports and heater.

Standard kit height 83 1/2".

Most Saunas are 7' height or lower. Minimum height is generally 75" to 78" depending on heater model. Maximum sauna height should never be higher than 8'. If you really want higher, we strongly urge being as close to 7' as you are willing to go; i.e. 7'-4" or 7'-6".

STRAPPING: For standard horizontal lining, strapping is not required. If lining vertically, strap (1 × 2 spf) over the foil to change direction. Can be used to create air space, but it is not necessary.

WIRING: Electrical rough-in of heater, control and light should be done at this time. If using an outside control, the thermostat should be installed at this stage. (See heater specifications and control wiring diagrams for wire and breaker sizes.) Hook-up of the heater and light can be done after the sauna is completed.

INSULATION: The space between the studs in the walls and ceiling is filled with 3-1/2", R-12 fiberglass insulation.

WE SUPPLY:

- Foil Vapour Barrier (apply over the inside edge face of studs over the insulation).
- Tongue & groove cedar lining
- Benches
- Heater with rocks
- Heater Guard
- Doors
- Outlet cedar slide vent
- Cedar Floor (optional)

Frameless glass door is standard. Frameless glass door has jamb on four sides. And comes with detachable spacer for bottom which has channel for back up ventilation

With included spacer blocking at bottom, rough opening is 27-1/2" x 76-1/2"

Cedar framed door style Rough Opening 26" x 76-1/2"

SAUNA KIT ROUGH IN DETAILS

ROUGH OPENING: If unsure which door you want, we recommend going with the larger. You can always reduce and trim later.

Frameless Glass Door = 24" x 72". With bottom spacer, Rough Opening=27 1/2 x 76 1/2".)

Cedar Door Style. Size = 24" x 74". Standard Rough opening=26" x 76 1/2".

Larger and custom doors available (i.e Tall Door=24"x78", Commercial Door=28"x78", Handicap Access=36"x78")

SAUNA DOORS SHOULD OPEN OUT.

OTHER CONSIDERATIONS

DRAINAGE: Commercial (public) saunas should have a drain in the center of the floor (sloped to the drain) to facilitate cleaning.

Most residential saunas have drains, but it is not essential. Water should only be used in moderation. (Our rule of thumb: If you are doing complete reno; i.e., breaking floors, new shower & bathroom, etc., we would suggest a sauna drain. If you are putting sauna in to an already finished area, it is likely not worth the cost to add a drain.

TILE: For residential, tile is attractive and functional; however, it is also acceptable to leave cement. If sauna is on upper level with wood sub-floor, there should be a rubber membrane, cement scratch coat and tile (like shower floor). If floor is sloped to drain, mosaic tiles are best.

You may add a tile baseboard up the wall 2-3".

HORIZONTAL LINING IS STANDARD. CHECK YOUR MATERIAL LIST TO CONFIRM YOUR SAUNA LINING

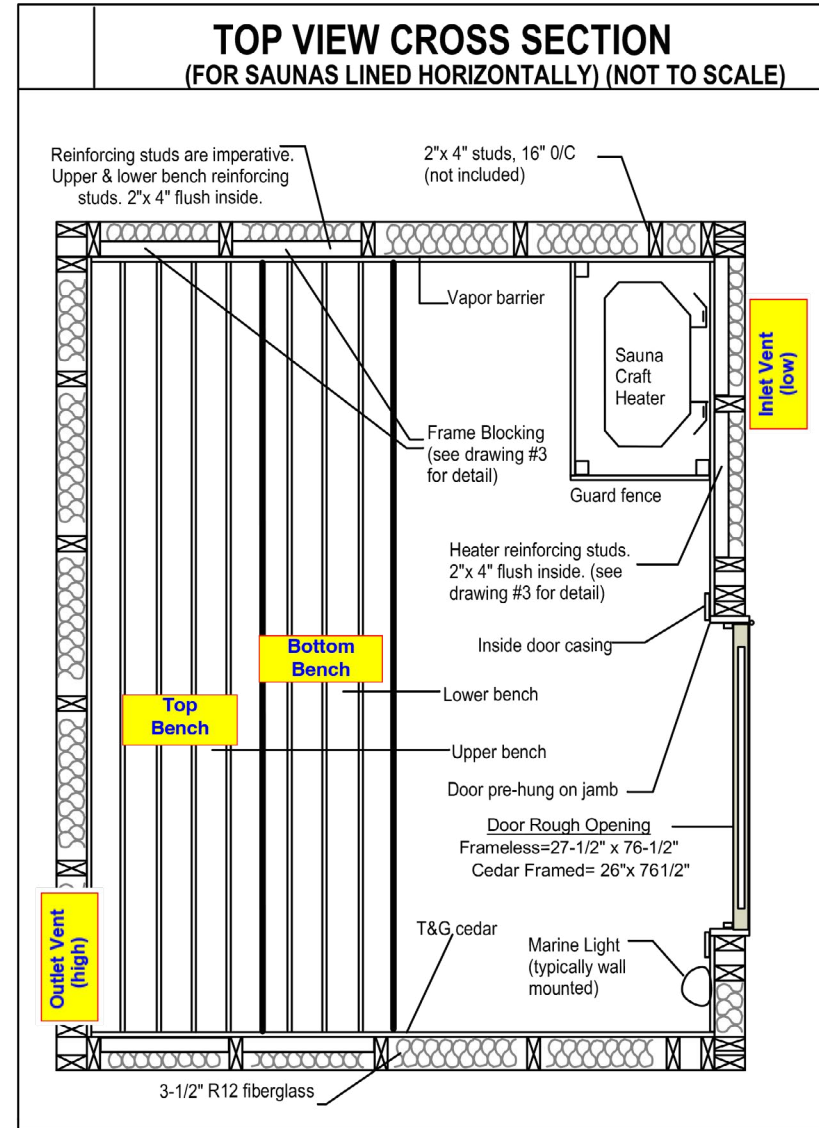
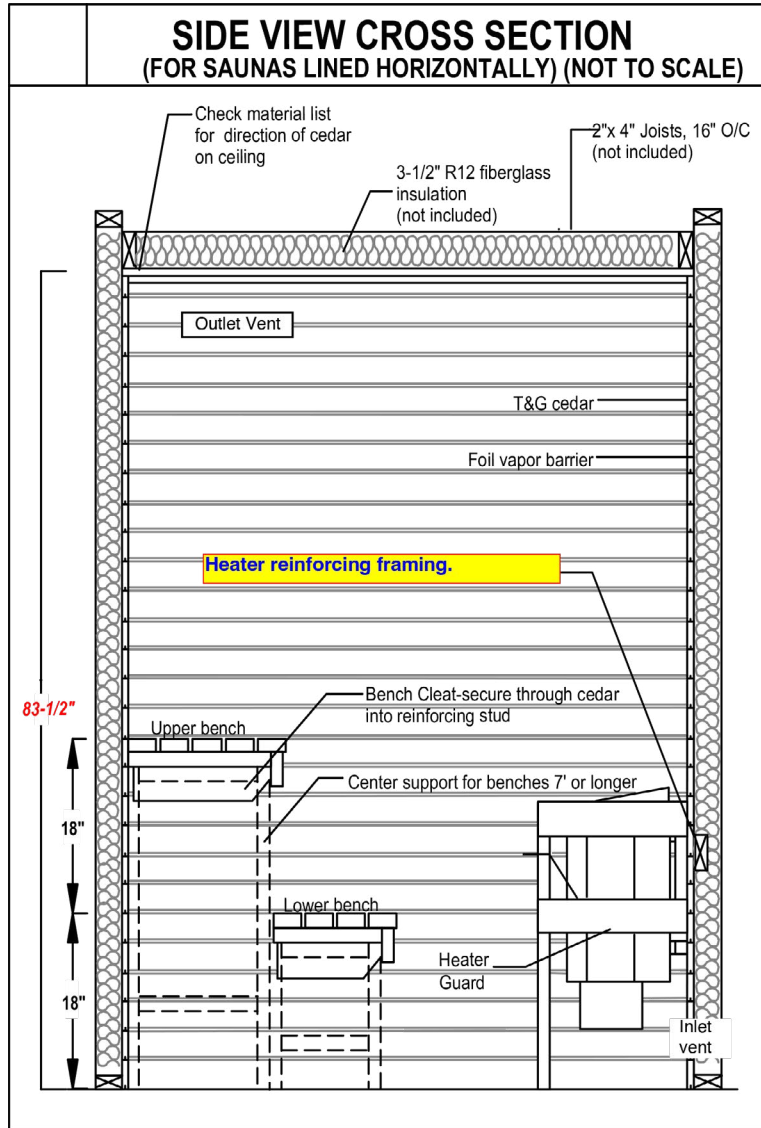

NOTE: This drawing shows standard sizes & dimensions. It may not reflect your exact sauna. Check your Material List for specifics for your sauna

SPRUCE/PINE BENCH BLOCKING (NOT INCLUDED)

2x4 Bench and 1x4 Benches



Cedar cleat (with kit) mounts through cedar lining into blocking.

2x4 Bench Top blocking elevation:
LK Plus, LK Premium,
LK Knotty (with 2x4 bench tops)

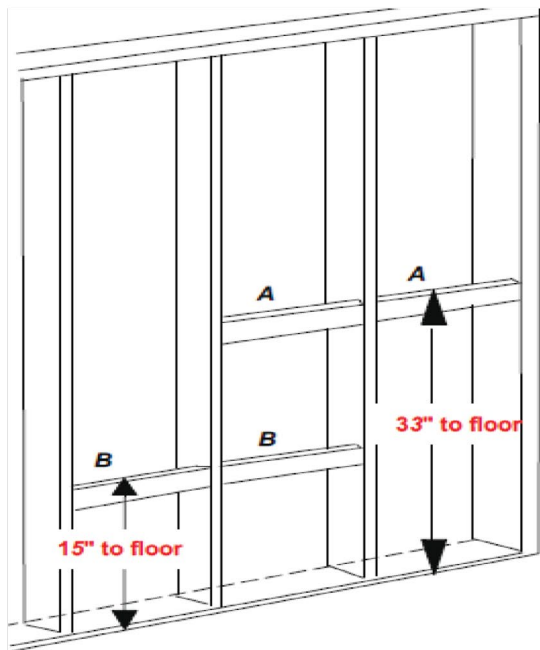

1x4 Bench Top blocking elevation:
LK Knotty (with 1x4 bench tops)

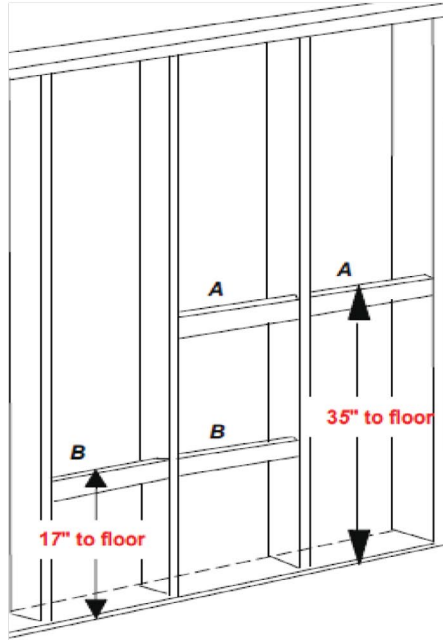

Floating Benches

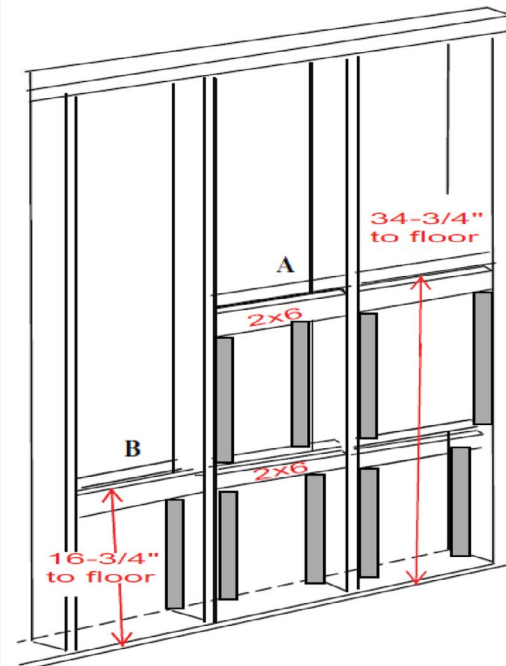

A = Top bench: From floor to top edge of blocking.
B = Bottom bench: From floor to top edge of blocking.

REINFORCING STUDS FOR HEATERS

Sauna Craft

(Add *blocking* on adjoining wall if heater to become mounted)

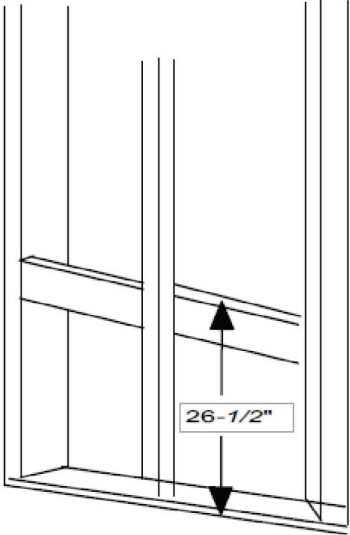

26-1/2"

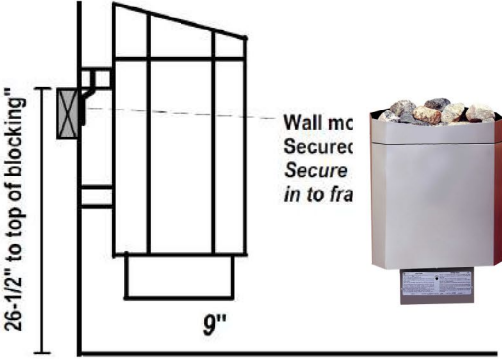

26-1/2" to top of blocking"

Wall mc Secure
Secure
in to fra

9"

Tylo

From top of
2x4 blocking
to the floor

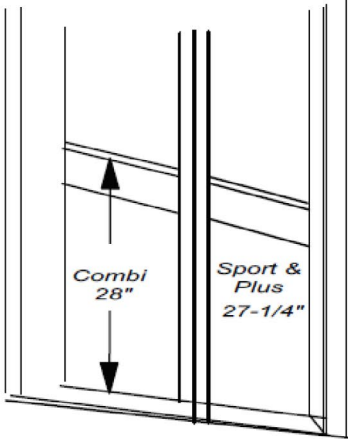

Combi
28"

Sport &
Plus
27-1/4"

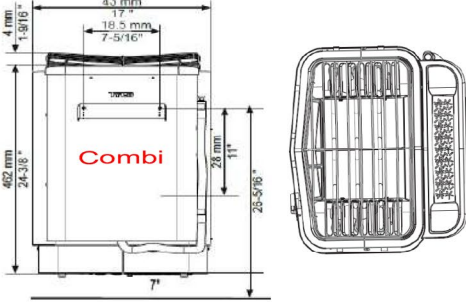

Combi

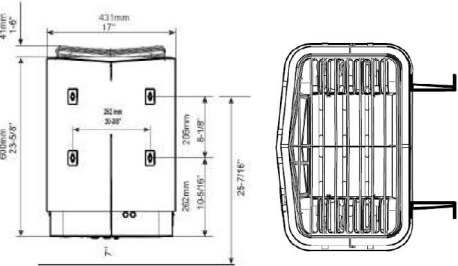

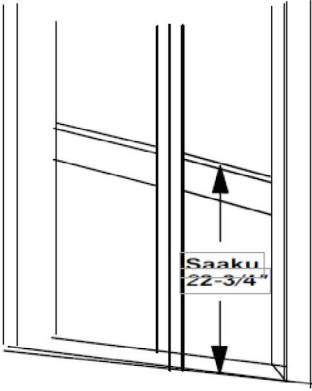

Sport & Plus

Saaku.

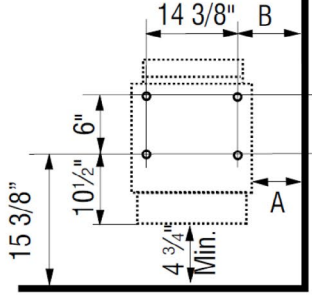

Saaku
22-3/4"

TONGUE & GROOVE HIDDEN NAILING

1 - 1/4" galvanized finishing nails for lining (supplied). Many prefer to use their own brand of nail gun for this task. Nail through the tongue and hide the inside groove.

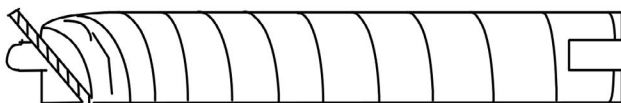

VENT DETAILS

Proper sauna venting is essential to sauna heater operation and to heat the sauna room effectively. Sauna ventilation is passive, and there is no mechanical fan. It is not part of the HVAC or bathroom exhaust.

INLET goes low behind the heater (usually on the front wall). Typically, it is simply holes drilled through cedar on the sauna side.

Fixed cedar grill (instead of holes) is available as an option. The exterior has an aluminum grill (not included) to match the exterior décor.



Fixed cedar grill: Optional with LK Plus. Incl with LK Premium

OUTLET is located high on the wall, diagonal from the inlet.

Cedar slide cover on the outlet (sauna side). The exterior has an aluminum grill (not included) to match the exterior décor.



Slide Vent Cover: One is included with every sauna material kit.

Exterior Grill: This is not included. Select one to match your décor.

SLIDE VENT COVER

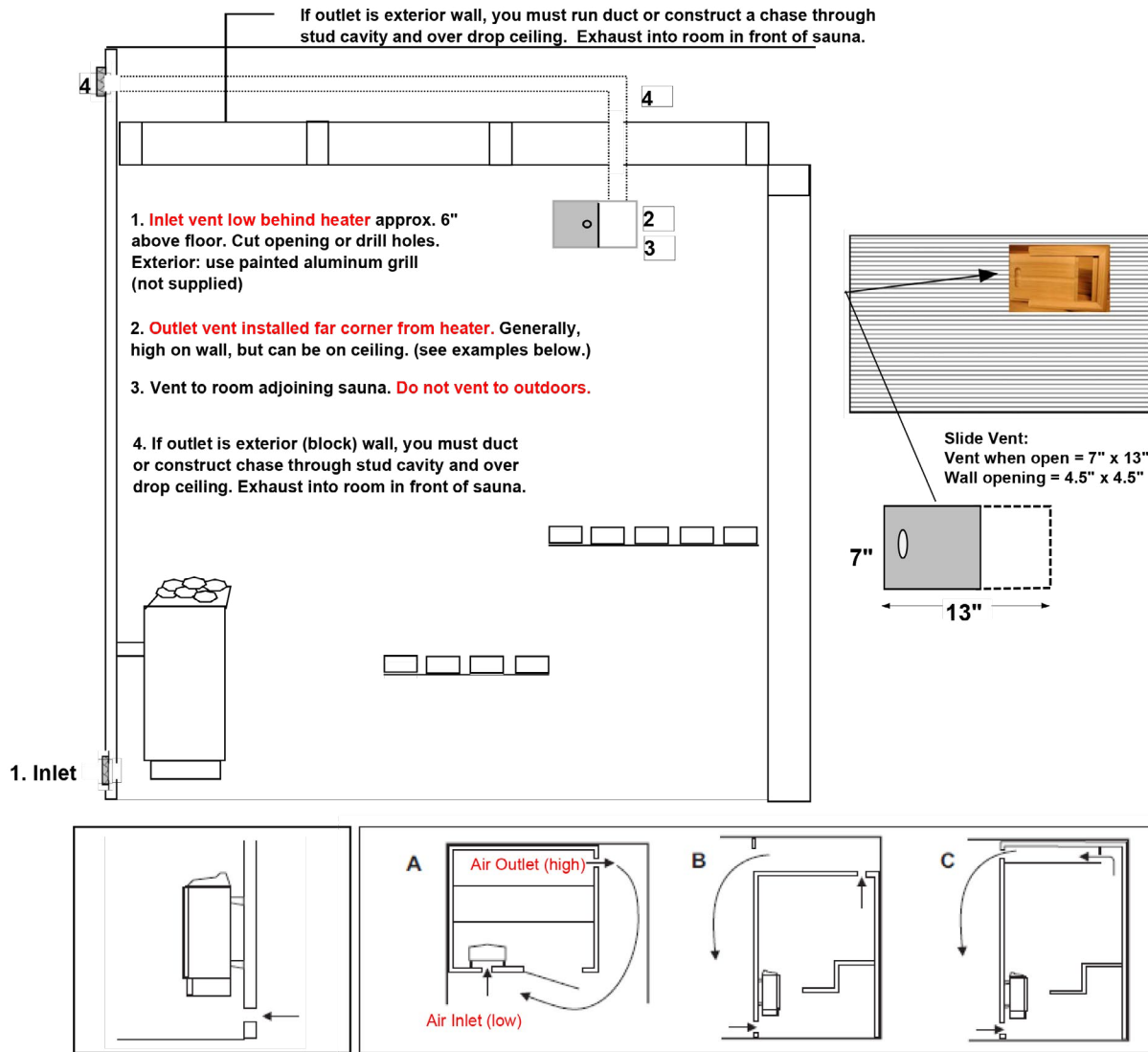

The inlet vent should be driven straight through the wall directly below the center of the heater. The cross-section of the vent for a wall-mounted sauna is approx. 19 sq.in. For larger saunas, approx. 40 sq.in.

Position the air inlet and outlet vents as far away from one another as possible (diagonally opposite). The outlet vent should be located high on a wall or in the ceiling and should have the same cross-section area as the inlet vent. Spent air should always be led back into the house – not discharged directly to the outside.

CAUTION: Do not install inlet and outlet vents on the same wall. Bad ventilation can be worse than no ventilation.

A: Outlet vent through the sauna wall (seen from above). The vent is placed high up, near the ceiling.

B: Outlet vent through the cavity above the sauna ceiling (seen from the side).

C: Outlet vent through a drum under the ceiling in the sauna (seen from the side). The outlet duct should be placed at an angle between the ceiling and the wall. The drum can be built out of wooden paneling and have the same area as the outlet vent.

Inlet: If you're drilling holes for an inlet, these must equal the specified sq-inch requirement. Six 2" or eight 1.75" holes are sufficient.

SAUNA DOORS

NOTE: Rough Opening means above the “finished” floor, i.e., above the tile.



Frameless

R/O=27-1/2" x 76-1/2 incl
bottom spacer with gap

(Hinge is reversible)



Cedar Framed Insulated Glass

R/O=26" x 76-1/2 gap under the
door (non-reversible)

NOTE: Gap or spacer can be deleted if you have effective cross ventilation as detailed in the manual.



Trim/Double Header

If you don't use a frameless door bottom spacer, or the door is shorter than R/O for another reason, you can “double case” the header.



Tips

If you don't want to see screws on the jamb, you can screw behind the stops.

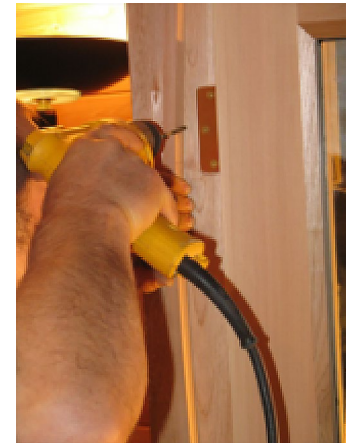

After installing the door, replace the center screw on each hinge with the longer screws provided with the kit.



NOTE: We do not provide instructions for how to hang a door. That is not something unique to saunas. We assume the installer knows how to shim, square, and secure a door in place. If not, there are numerous YouTube video demonstrations.

JAMB EXTENTION DETAIL

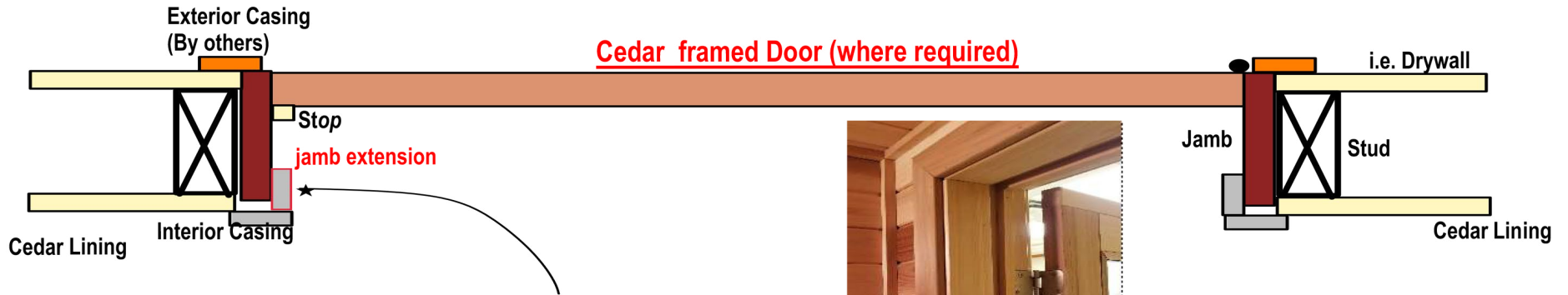

Where stud wall is thicker than standard; i.e 2x6 studs, a 1x2 for jamb extension.
 Secure jamb extension to jamb so that it extends flush with inside cedar lining of sauna.
 Install inside casing to conceal the gap at the jamb.

Exterior finish & Casing (By others)

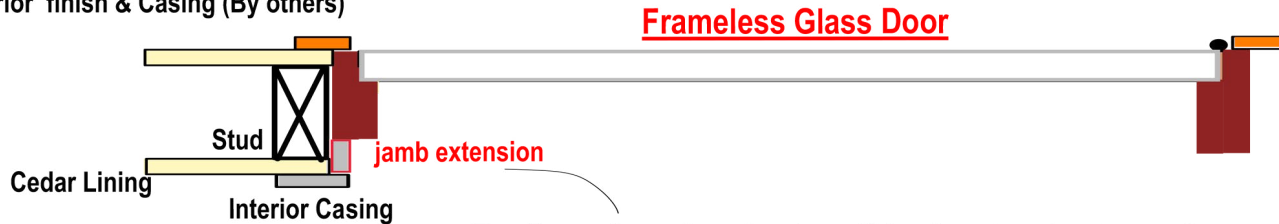

*For Frameless door jamb, nail jamb extension to stud.
 Trim so its flush to inside cedar lining.
 Use 1x2 jamb extension. Trim as needed*





SaunaFin
Saunas & Steambaths

SAUNAFIN SAUNA & STEAM

106 Rayette Road, Unit 1, Concord, ON, L4K 2G3

TOLL-FREE

1-800-387-7029

PHONE

905-738-4017

EMAIL

info@saunafin.com

WEB

www.saunafin.com