



SaunaFin

Saunas & Steambaths

MARINE LIGHT INSTRUCTION MANUAL

INSTRUCTION MANUAL: EXTERIOR LIGHT FIXTURE

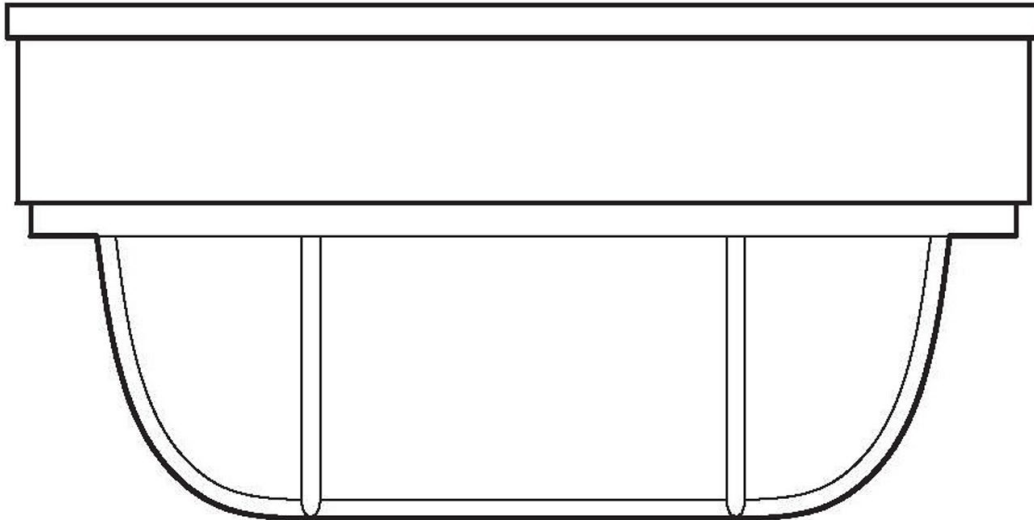

Wall Mount

(Recommended because of typically low sauna height)



Ceiling Mount

(Avoid installing over heater or over bench seating area)

CAUTION!

1. Before starting installation of this fixture or removal of a previous fixture, disconnect the power by turning off the circuit breaker or by removing the fuse at the fuse box.
2. CONSULT A QUALIFIED ELECTRICIAN IF YOU HAVE ANY ELECTRICAL QUESTIONS.

TOOLS REQUIRED FOR INSTALLATION AND ASSEMBLY (not included):

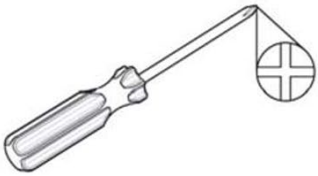

Phillips screwdriver



Flathead screwdriver



Wire cutters



Wire strippers



Light Bulb (60 watt maximum or CFL equivalent)



Safety goggles

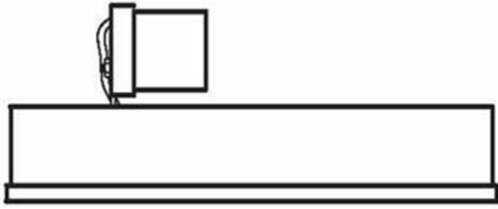

Electrical tape

PARTS INCLUDED FOR ASSEMBLY (parts are not to scale):

1 ea Fixture Pan (#1)



1 ea Cage (#2)



2 ea Cage Screws (#19)

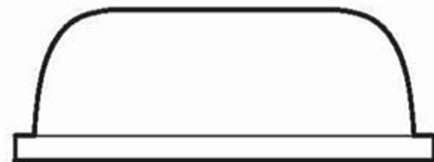

1 ea Diffuser (#18)

ASSEMBLY INSTRUCTIONS

1. Carefully unpack the fixture. Lay out all parts on a clean surface.
2. Before continuing Assembly, please proceed to the Installation Instructions.
3. Install an incandescent Light Bulb (#17) or a Listed SBCFL (Self-Ballasted Compact Fluorescent Lamp [not provided]) into the socket of the Fixture Pan (#1). Do not exceed a 60 watt incandescent light bulb, or a 14 watt SBCFL.
4. Slide the the Diffuser (#18) into the Cage (#2).
5. Secure the Cage (#2) onto the Fixture Pan (#1), using the Cage Screws (#19).

ASSEMBLY:

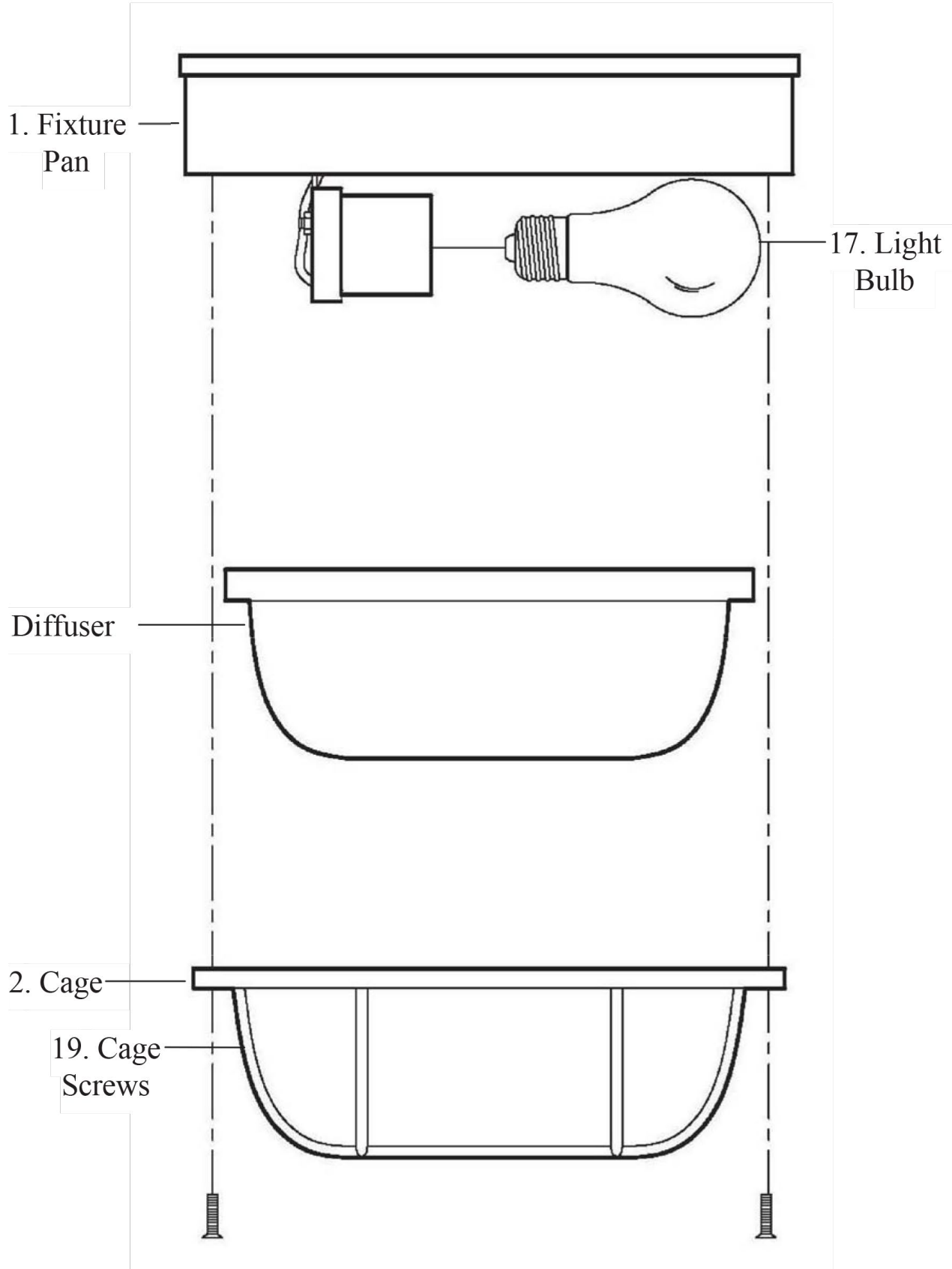

PARTS INCLUDED FOR INSTALLATION (parts are not to scale):

1 ea Mounting Bracket (#7)

2 ea Bracket Mounting
Screws (#8)

2 ea Lock Nuts (#3)



2 ea Hex Nuts (#9)

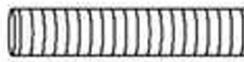

1 ea Nipple



3 ea Wire Nuts (#14)

INSTALLATION INSTRUCTIONS

1. Thread the Hex Nut (#9) onto the Nipple (#6). Thread the Nipple (#6) into the center hole of the Mounting Bracket (#7). Do not tighten the Hex Nut (#9) at this time.
2. Pull the power supply wires out from the Outlet Box (#4), and mount the Mounting Bracket (#7) to the Outlet Box (#4), using the Bracket Mounting Screws (#8).
3. Attach the Black Supply Wire (#5) to the Black Fixture Wire (#12) and the White Supply Wire (#16) to the White Fixture Wire (#13) using Wire Nuts (#14). Connect the Fixture Ground Wire (#11) and the Supply Ground Wire (#15) together using a Wire Nut (#14). Wrap all wire connections with electrical tape for a more secure connection. *Note: If you have electrical questions, consult your local electrical code for approved grounding methods.*
4. Carefully tuck all Wires and Wire Nuts (#14) into the Outlet Box (#4). Place the Fixture Pan (#1) over the Outlet Box (#4), flush against the wall surface, making sure the Nipple (#6) feeds through the hole of the Fixture Pan (#1). Adjust the Nipple (#6) so that it protrudes about ¼ inch from the surface of the Fixture Pan (#1). Remove the Fixture Pan (#1) from the wall and tighten the Hex Nut (#9) against the Mounting Bracket (#7). Replace the Fixture Pan (#1) over the Outlet Box (#4) and thread the Lock Nut (#3) onto the Nipple (#6) to secure the Fixture Pan (#1) against the wall.
5. Proceed back to the Assembly Instructions.
6. Installation is complete. Turn on power at the circuit breaker or fuse box. Turn the light switch on to activate the fixture.

Cabin or Barrel log Saunas:

Recommend low profile “pancake box” rather than standard octagon box. Can be surface mounted flush inside sauna. And light can be fitted over.



Pancake Box

Built Sauna Kit:

Use standard octagon box. Typically wall mounted.



Octogon Box

INSTALLATION:

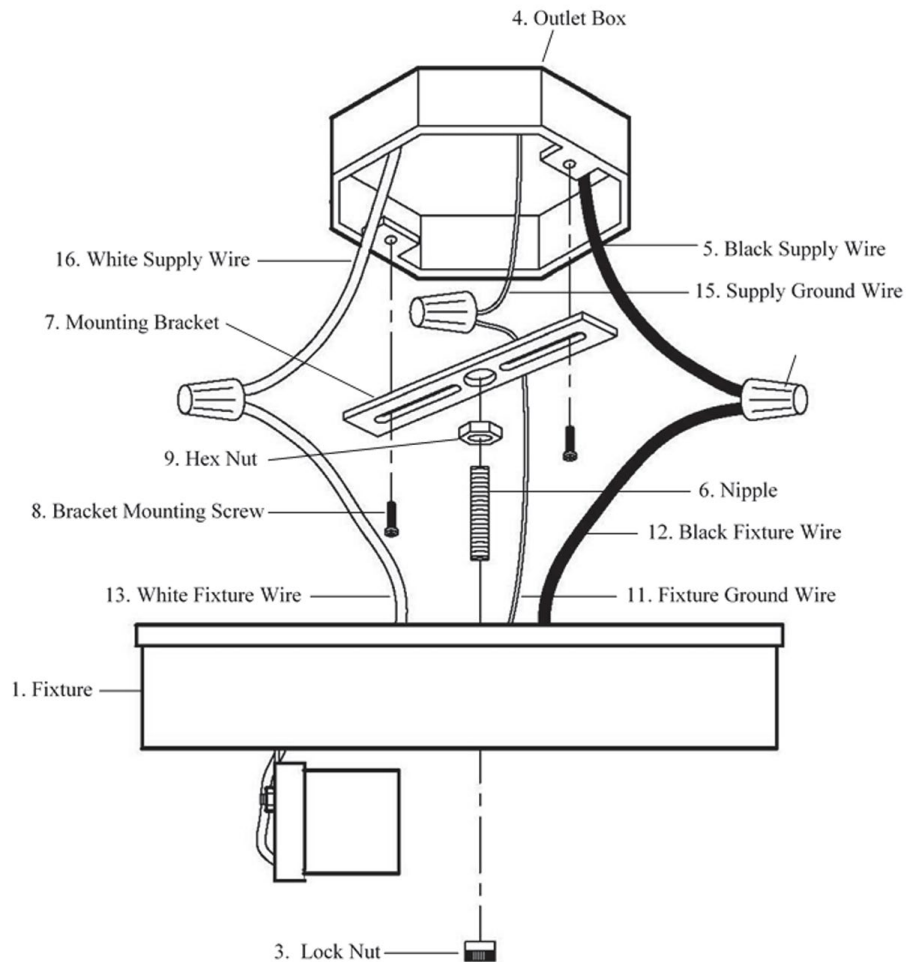

TROUBLESHOOTING

	Possible Cause	Corrective Action
Light will not turn on	Power is off	Make sure power supply is on
	Faulty switch	Test or replace switch
	Faulty wire connection	Check wiring
Fuse blows or circuit breaker trips when light is turned on.	Crossed wires or power wire is grounding out	Check wire connections

PRODUCT MAINTENANCE

1. To clean the outside of the fixture, use a dry or slightly dampened clean cloth (use clean water, never a solvent) to wipe the surface of the fixture.
2. To clean the inside of the fixture, first disconnect power to the fixture by turning off the circuit breaker or by removing the fuse at the fuse box. Next, use a dry or slightly dampened clean cloth (use clean water, never a solvent) to wipe the interior surface of the fixture.
3. Do not use any cleaners with chemicals, solvents or harsh abrasives. Use only a dry soft cloth to dust or wipe carefully.



SaunaFin
Saunas & Steambaths

SAUNAFIN SAUNA & STEAM

106 Rayette Road, Unit 1, Concord, ON, L4K 2G3

TOLL-FREE

1-800-387-7029

PHONE

905-738-4017

EMAIL

info@saunafin.com

WEB

www.saunafin.com